

UNDERSTANDING BALLAST LED DISPLAY & DRY CONTACTS

The CoilClean IL incorporates unique features into the ballast control box. These include LED status display as well two pairs of dry contacts designed to communicate with building automation systems.

LED status display

The ballast box may have one or two ballasts incorporated into the box depending on how many units were ordered. If only one ballast is incorporated into the ballast box, you will notice only one wire set incorporated into the box and a black button covering where a second LED would be. If the ballast box incorporates two ballasts there will be two LEDs that corresponding to each UV lamp.

- (Green) ● UV SYSTEM 'ON' : The system is functioning normally
- (Yellow) ● UV LAMP TO BE REPLACED : Notifies the user that the lamp has reached the end of its serviceable life (24 months of real-time operation) and must be replaced
- (Red) ● UV LAMP FAILURE : Flashes if lamp has failed or the unit is powered ON with no UV lamp installed
- (LED OFF) ● NO POWER (LED OFF) : There is no power being delivered to the system or defective power supply

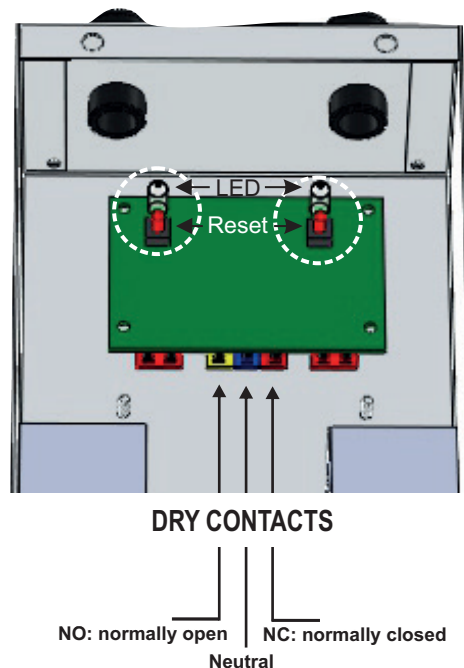

A reset button is located under the LED (when cover is removed) allowing the user to "Reset" the timer back to zero. To be performed after UV lamp replacement.

Dry contacts for building automation integration

Each CoilClean IL system includes a pair of dry contacts (NO & NC). Dry contacts make it possible for the CoilClean ILs to be easily tied to a building automation system.

CERTIFICATIONS

CSAC22.2 113#Issue: 2015/05/01 Fans and ventilation
UL 507 Issued: 1999/12/13 Ed: 9 Rev. 2012/06/18 Electric Fans
Marking : cETLus

MAINTENANCE

Lamp Change-Out: 17,000 hours (2 years)

Disconnect all power before performing any maintenance or service. UV lamps need periodic replacement to maintain design specifications. Replace UV lamps after 17,000 hours of operation. Use caution when removing and inserting UV lamps from the metal spring clamps. Then press on the reset button for resetting timer to zero.

Use only specified Sanuvox UV lamps with this UV system. Other UV lamps may plug into the connector, but they should not be used. The use of an incorrect lamp can result in damage to the system or UV lamp and void the warranty.

WARRANTY

Lamp Warranty: 2 years
Electronics: 1 year
Ballast Warranty: 15 years

PART NUMBERS

CoilClean IL replacement UV lamps

LMPHGS120: T6 High-Intensity Germicidal (UVC) 12" Straight UV Lamp for IL12
LMPHGS180: T6 High-Intensity Germicidal (UVC) 18" Straight UV Lamp for IL18
LMPHGS240: T6 High-Intensity Germicidal (UVC) 24" Straight UV Lamp for IL24
LMPHGS300: T6 High-Intensity Germicidal (UVC) 30" Straight UV Lamp for IL30
LMPHGS400: T6 High-Intensity Germicidal (UVC) 40" Straight UV Lamp for IL40
LMPHGS500: T6 High-Intensity Germicidal (UVC) 50" Straight UV Lamp for IL50
LMPHGS600: T6 High-Intensity Germicidal (UVC) 60" Straight UV Lamp for IL60

CoilClean IL replacement ballast

Multi voltage BST120/277SHS for IL12, IL18, IL24 IL30, IL40, IL50, IL60

Flange mounting bracket

FLANGE part# MSC9
CONNECTOR part# MSCCON19

COILCLEAN IL INSTALLATION MANUAL

SAFETY CONSIDERATIONS

Installation and servicing of air-conditioning equipment can be hazardous due to system pressure and electrical components. Only trained and qualified service personnel should install, repair, or service air-conditioning equipment. Untrained personnel can perform basic maintenance functions such as changing lamps. All other operations should be performed by trained service personnel. When working on air-conditioning equipment, observe precautions in the literature, tags and labels attached to the unit or accessory, and other safety precautions that may apply. Follow all safety codes. Wear safety glasses and work gloves.

WARNING

Before installing or performing maintenance or service on the unit, turn off unit and disconnect from power source. Electrical shock can cause injury or death. There may be more than one disconnect switch.

Never expose eyes or skin to ultraviolet light from any source. The unit MUST be DISCONNECTED from power source before performing maintenance or service. Personal injury may result.

Do not touch lamp glass without gloves. Reduced performance of lamp may result. Clean lamp after handling.

The UV lamp contains a small quantity of mercury. If a lamp breaks, clean and dispose of with care.

Use only specified replacement lamps with your unit. Use of an incorrect lamp can result in damage to the unit and/or lamp.

IMPORTANT NOTICE

UV lamp can be disposed/recycle after use as for any other fluorescent bulb.

CoilClean ILs are designed for continuous operation. Do not cycle the system through a relay connected to the fan blower.

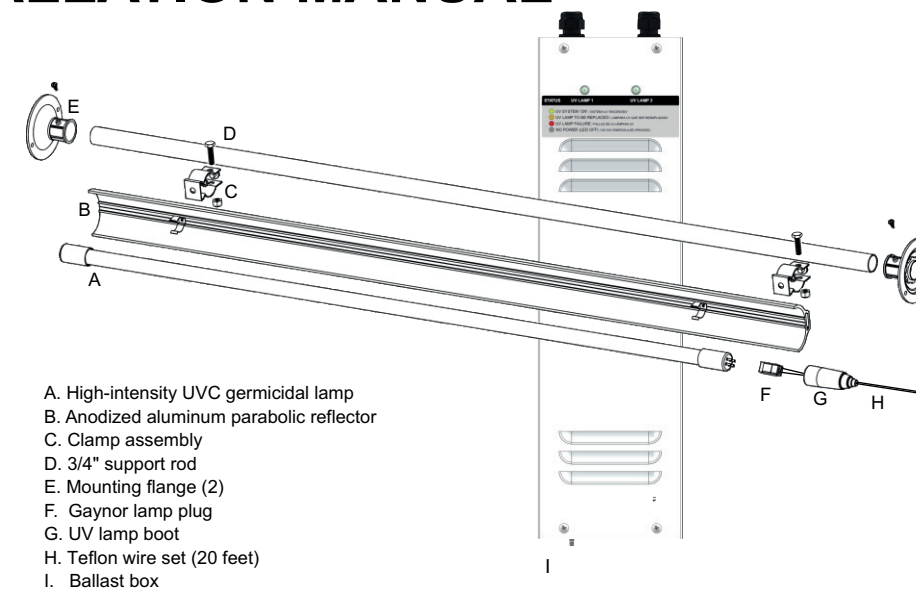

- Also includes:
- J. Coupler
 - K. Cotton gloves & hardware
 - L. UV caution decal

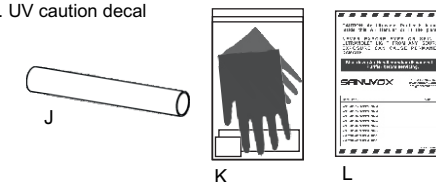

SELECTING THE APPROPRIATE LOCATION

Refer to your customized Sanuvox sizing & placement proposal as to where the CoilClean ILs are to be installed.

IL's can be installed on the upstream or downstream side of the coil. If you do not have the Sanuvox sizing & placement proposal, call 1-888-726-8869 where Sanuvox will provide one at no-charge.

The lamp assembly must be field-installed inside the air handling unit, either horizontally to the side panels, or on the coil frame, using field-mounted brackets or vertically, to floor and ceiling of AHU. The ballast box are to be installed on the outside of the AHU, in a dry area. Make sure that the site can be supplied with the necessary power requirements. Power consumption is 1.0 amp for 40" lamps, 1.25 amps for 50" lamps and 1.5 amps for 60" lamps. Ensure that there is adequate clearance for service. If a humidifier is present, the ideal location for the germicidal coil cleaner is in the air stream before the humidifier. If space does not permit, the germicidal coil cleaner may be installed after the humidifier. The operating temperature range is 50 to 115 F. Operating outside of this range will result in decreased performance.

NOTE: The CoilClean IL and ballast boxes are NOT waterproof. If installed outdoors, ballast boxes must be installed in a watertight and ventilated enclosure.

QUESTIONS ON INSTALLATION?
CALL SANUVOX AT 1-888-726-8869

INSTALLATION

Perform the following procedure to assemble the CoilClean IL

1. Turn OFF all power to HVAC equipment.
2. Remove the CoilClean IL from its packaging. Use care in handling the aluminum reflector/shield, as the lamp is fragile.
3. Unpack the ballast box.

NOTE: Post can be installed horizontally or vertically. For that later option, more posts are needed and flanges. Description afterward is for horizontal install.

To mount 3/4" support rod to the mounting flanges

4. Measure and cut the rod to desired length. Insert the 3/4" support rod into the two mounting flanges and tighten the two Phillips screws on either mounting flange. If using more than one CoilClean IL fixture, multiple support rods may be joined together by using the included coupler. Refer to "Using the COUPLER to join multiple 3/4" support rods" on the bottom of page 3.

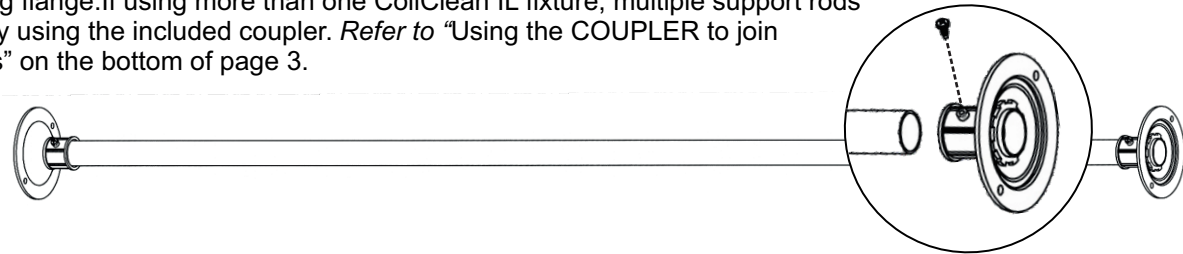

5. The CoilClean IL fixture is to be installed with the UV lamp facing the coil. The mounting flanges attach directly to the unit's side panel, or to the coil frame. NOTE: If it is not possible to attach the flanges directly to the unit's panels or to the coil frame, a bracket (field-supplied) is required or vertical installation.

- **Coupler tube:** In the event that the AHU side panels (that support the fixture) are wider than the included support rod or the installation requires multiple CoilClean ILs, the coupler tube can be inserted between two or more support rods or 3/4 EMT conduit allowing the support rods to be extended to desired lengths. Refer to "using the COUPLER to join multiple 3/4" support rods" on the bottom of page 3.

To mount the aluminum reflector to the support rod

6. Attach the clamps to the back of the aluminum reflector using the supplied Phillips screws and lock washer. The holes in the parabolic reflector are pre-drilled and pre threaded.



7. a) Attach the parabolic reflector to the support rod tightening the clamp securing the assembly in place.
b) While wearing the included cotton gloves, carefully "clip" the UV lamp using the metal spring clips into the parabolic reflector.
NOTE: For ease of operation, the lamp end with the four pins should be pointing in the direction of the ballast box.



Limit switch installation

8. To protect users from direct exposure to the ultraviolet rays, use a limit switch. The limit switch will shut down operation to the UV system should the access door be opened. A limit switch is available from Sanuvox (part# MSCSWC14).

INSTALLATION - continued

Ballast box installation

9. Remove the 4 x Phillips head screws from the ballast box cover. Mount the ballast box on the outside of the air handler, on a wall or other hard surface, attached using the 2 holes in the center of the ballast box. Be careful not to damage the wiring.

Wiring ballast box to the UV lamp(s)

10. Depending on configuration, there may be one or two ballasts incorporated into the ballast box (depending on how many units were ordered). The wire harness comes with 20 feet of Teflon wire set per ballast.

11. In order to facilitate running the wire set from the ballast to the UV lamp, the Gaynor plug and lamp boot are made to be installed after the wires have been run. To install: first slide the four (4) lamp wires through the UV lamp boot and then push each of the four (4) wires into the white Gaynor plug. As per the underneath example. Blue wire always in the dark side.

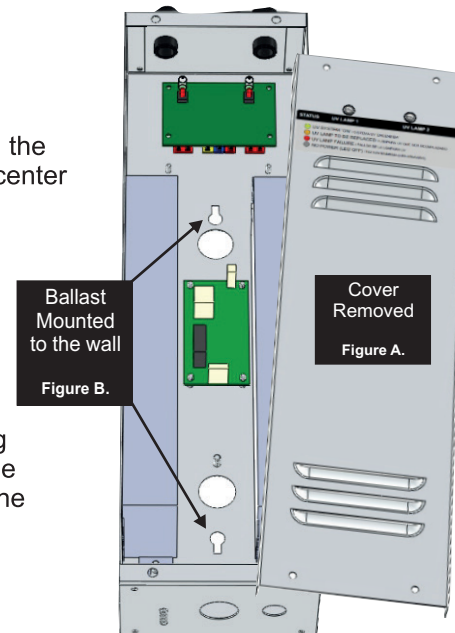

CONNECTIONS TO GAYNOR PLUG

Orientation of Gaynor plug is critical

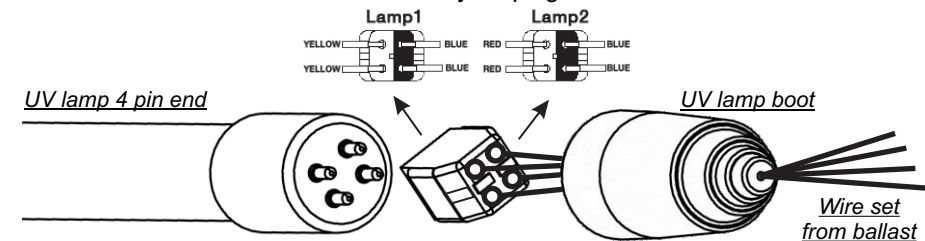

12. Carefully secure the white Gaynor plug to the end of the UV lamp. NOTE: The Gaynor plug fits on two of four ways. If the plug does not fit, just rotate the plug 1/4 turn left or right. The UV lamp boot is designed to seal the connection between the plug and the UV lamp as to reduce the possibility of moisture penetrating to the connection. NOTE: The UV lamp boot does not cover the entire end- cap (approx. 3/4").

Wiring to POWER

13. The CoilClean IL is powered by a multi voltage ballast 120/240v. With cover removed, pull the white (neutral) and black (hot) from the round knock-out at the bottom of the ballast box. CONNECT TO POWER using the included yellow quick connect.

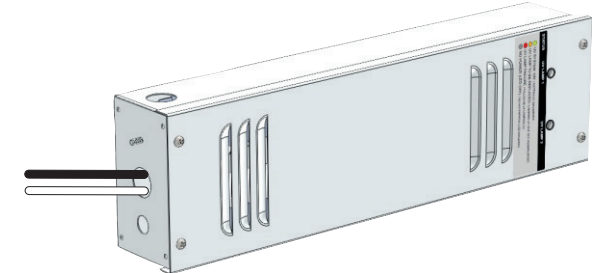

Using the COUPLER to join multiple 3/4" support rods

The coupler tube can be inserted between two or more support rods or 3/4" EMT conduit allowing the support rods to be extended to desired lengths.

1. Insert inner tube halfway inside one support rod.
2. Using a 1/4" hexagon drill, screw one self tapping screw. The hole in the support rod is pre-drilled.
3. Insert the other half of the inner tube into the other support rod and follow the instructions in step 2.
4. The completed assembly with the inner tube coupler joining two support rods.

